

INSTALLATION INSTRUCTIONS: STAINLESS ADVENTURE HI-OUTPUT 450 SLIP-ON 2021 HARLEY-DAVIDSON PAN AMERICA PART# 16533

READ ALL INSTRUCTIONS BEFORE BEGINNING INSTALLATION

Congratulations, you have purchased the finest exhaust system available for your motorcycle. Your Vance & Hines exhaust is designed and crafted for performance, quality, and style. Please follow the instructions below, check exhaust system for missing or damaged parts and if you need any assistance please contact our technical support line (562) 921-7461.

Fits 2021 Harley-Davidson Pan America Models

Qualified Manufacturer Declared Replacement Part for 2021 Harley-Davidson Pan America Models.

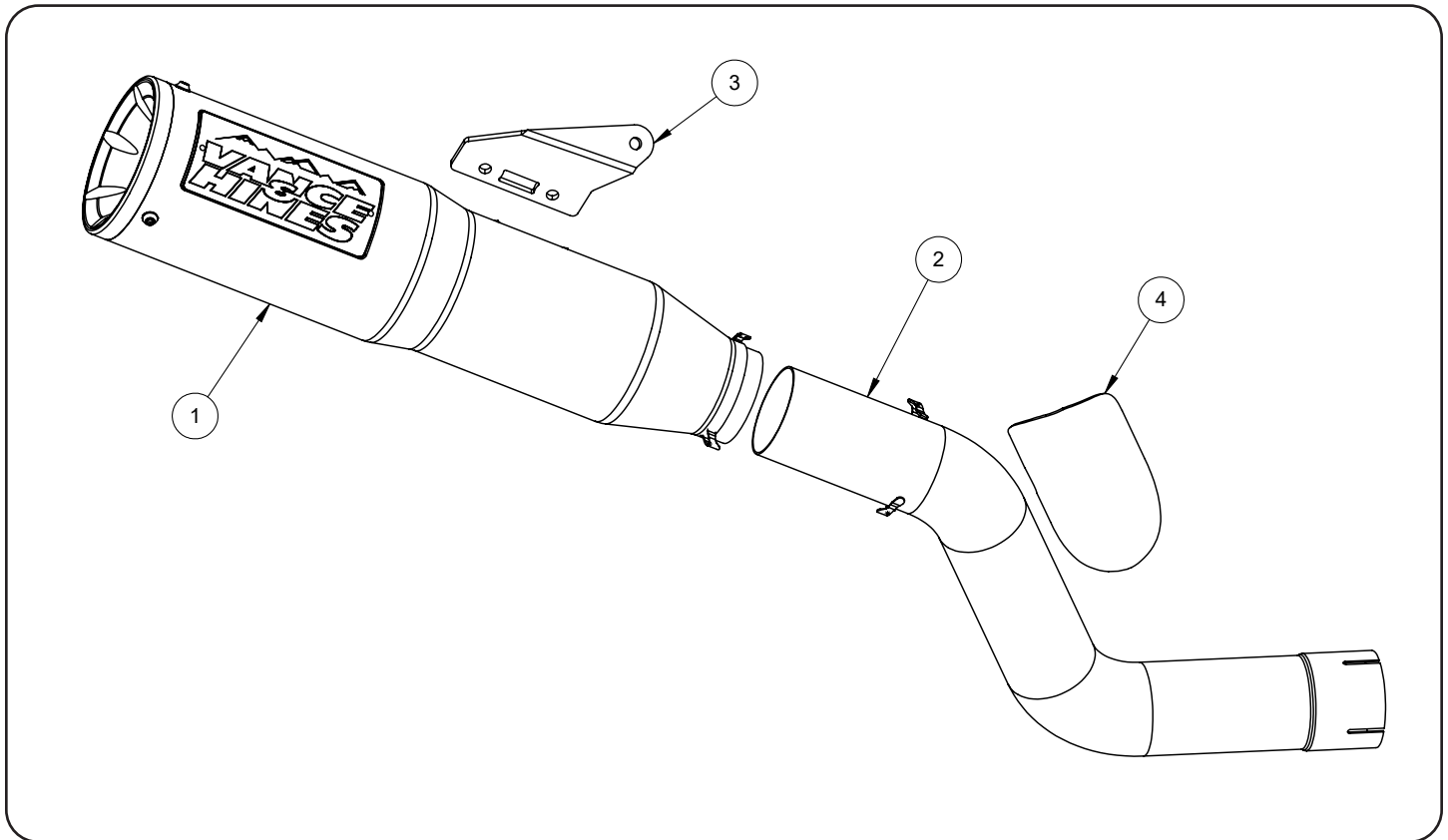

PARTS LIST

ITEM NO.	PART NO.	Description	Qty.
1	D533RB-S	Muffler Can Assembly	1
2	D530RB	Mid-pipe Assembly	1
3	1245	Mount Bracket	1
4	D530HP	Heat Shield	1
5	A195HW	Dogbone Nut Plate	1

ITEM NO.	PART NO.	Description	Qty.
6	A240HW	5/16"-18 X 5/8" FB	2
7	A115SP	Spring	2
8	A337HW	2.625" Torca Clamp	1
9	A276HW	1.18-2.75" SS Clamp	2
10	A260SP	Spring Puller	1
11	A852HW	M8x1.25 Flange Nut	1

HARDWARE

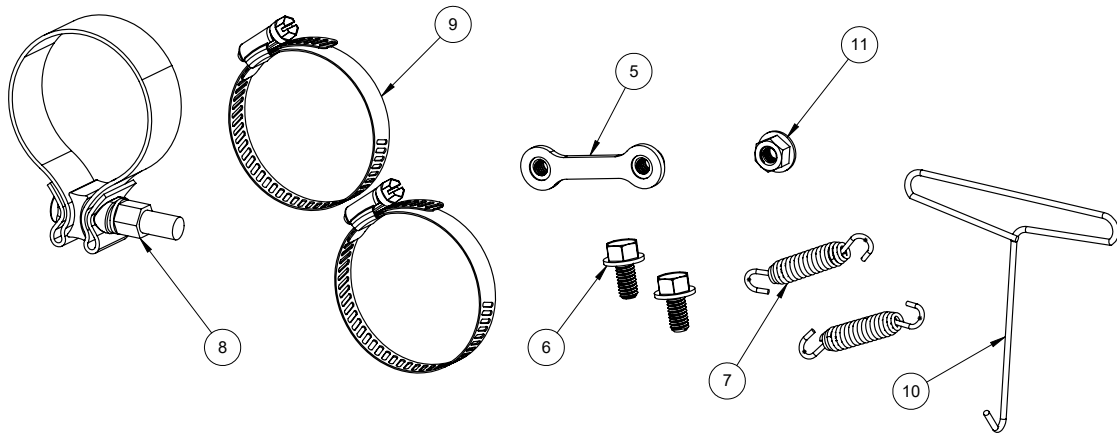

TOOLS REQUIRED

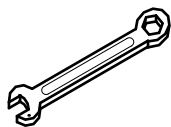

Combination Wrench:
5/16", 1/2", 9/16",
12mm

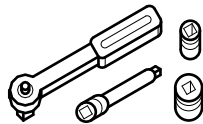

**3/8" Drive Ratchet w/ 4" ex-
tension, 5/16" & 1/2" Sockets,
15mm Deep Socket, T40 Torx
Socket**

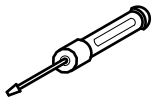

Flat Head Screwdriver

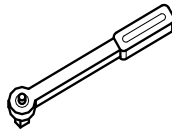

Ft-lb Torque Wrench

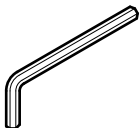

T27, T40 Torx Wrench

REMOVAL OF STOCK EXHAUST

1. Remove the center stand and the right side foot controls. **NOTE:** support brake cylinder and lever with a cable tie or wire. Do not allow the controls to hang by the brake hose.
2. Remove the stock heat shield from the OEM muffler by removing the mounting screw and loosening the heat shield clamp.
3. Loosen the clamp holding the stock muffler to the resonator chamber, then remove the bracket screw mounting the muffler to the frame. Slide the stock muffler off of the resonator chamber. **NOTE:** Set aside the bracket mounting screw for installation of the Vance and Hines Hi-Output Slip-on.
4. Loosen the clamp holding the resonator chamber to the head pipes and remove the mounting screw holding the resonator to the frame. Slide the resonator chamber rearward to remove from the head pipes and the rubber mounting bung.
5. Reinstall the center stand and right side foot controls. Tighten to manufacturer's recommended torque settings.

VANCE & HINES EXHAUST INSTALLATION

1. Install the 1245 muffler bracket (supplied) onto the muffler can assembly using the A195HW dogbone nut plate and 2x A240HW 5/16"-18 x 5/8" flange head bolts (Figure 2). **NOTE:** Hand tighten only at this time.
2. Install the A337HW Torca band clamp (supplied) over the front of the D530RB muffler mid-pipe so that the bolt and the clamping nut is facing outward (Figure 3). **NOTE:** New Torca band clamps are supplied, do not use the old clamps.
3. Slide mid-pipe over the stock exhaust head pipe. **NOTE:** Do not tighten the Torca clamp at this time.
4. Slide muffler can assembly onto the mid-pipe, then align the muffler bracket with the frame bracket and secure using the stock mounting bolt and the supplied M8 nut and washer. Adjust the position of the muffler on the bracket so that the distance between the spring clips is 2.0" (Figure 4) and then tighten the 5/16"-18 x 5/8" flange bolts on the mounting bracket.
5. Align the mid-pipe and muffler so that there is approximately 3/8" clearance between the swing arm and the mid-pipe and then tighten the Torca Band Clamp to 45 ft/lbs.
6. Install the 2x A276HW SS Hose Clamps onto the heat shield, orienting the screw heads so that they are facing downwards (Figure 5).
7. Install the heat shield onto the mid-pipe. Adjust the position of the heat shield so that the notch is aligned with the lower edge of the swing arm and tighten the clamps (Figure 6).
8. Using the supplied A260SP Spring Puller, install the 2x A115SP muffler springs onto the spring clips (Figure 4).
9. After installation and before starting motorcycle, completely clean pipes and mufflers with cleaning solvent and a clean, soft cloth that will not leave a residue. **NOTE:** Any residue, oil, or fingerprints may cause discoloration when the metal heats up.
11. Be sure to tighten all hardware before starting your motorcycle.
12. **IMPORTANT: AFTER TEST RIDE LET PIPES COOL DOWN AND RE-TORQUE TORCA MUFFLER BAND CLAMP.**

FIGURE 1



FIGURE 2

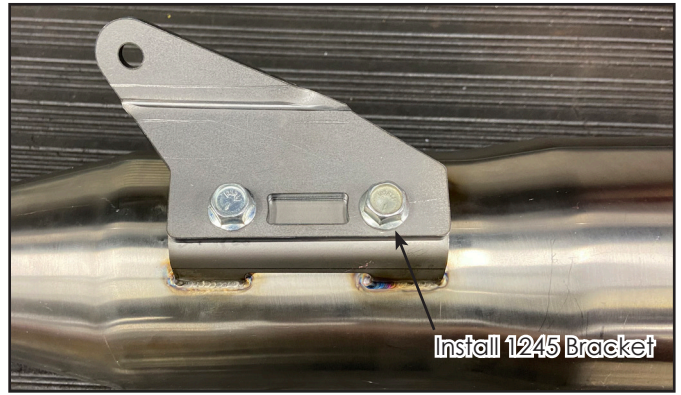

FIGURE 3

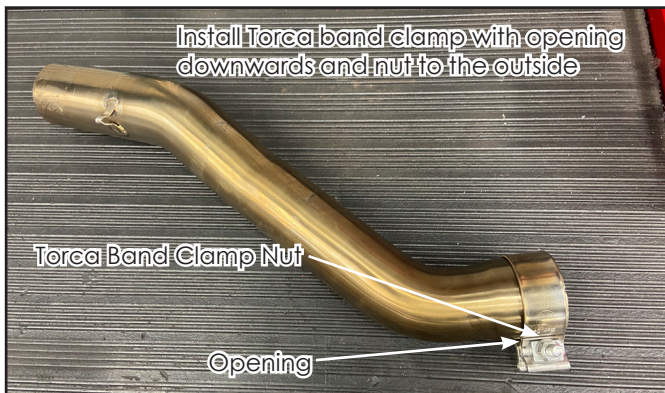

FIGURE 4

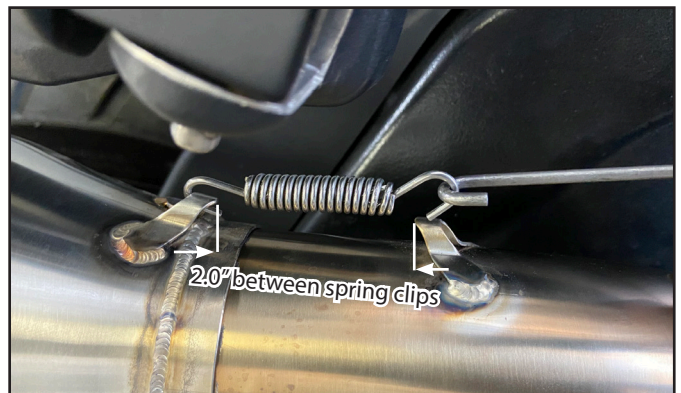

FIGURE 5



FIGURE 6



Emissions Notice:

In California, in order to meet Air Resources Board emissions requirements, certain aftermarket part applications have been identified as replacements, and others have received ARB Executive Orders. All other emissions related aftermarket parts are for competition use only. A list of replacement parts and EO parts, and corresponding fitment is provided at vanceandhines.com/california.

Warranty:

All Vance & Hines products are warranted against defects in material and workmanship for a period of 90 days. This warranty does not cover discoloration or rust. This warranty shall be limited to the repair or replacement of the product, which may be proven defective under normal use. Vance & Hines will not warranty any system that has been abused, misused, improperly installed or modified.

Dealers or distributors are not authorized to make dispositions binding upon Vance & Hines. Vance & Hines will not be responsible for any labor charges incurred in removing or replacing any system under warranty. A return authorization number and a copy of the original purchase invoice must accompany all returns. Parts returned without a return authorization may be refused.

13861 ROSECRANS AVENUE / SANTA FE SPRINGS, CA 90670
SALES: (562) 921-5388
TECHNICAL: (562) 926-5291
FAX: (562) 802-0110

vanceandhines
.com