

**MORE POWER : LESS NOISE**



Congratulations, you have purchased the finest exhaust system for your motorcycle on the market. Your Vance & Hines exhaust system is designed and crafted for maximum performance, a perfect fit, a great sound and unbeatable style. Please follow the installation instructions below and if you have any questions, please call our technical support line at (562) 926-5291.

Attention installer (if other than owner), please forward this instruction sheet to the owner of this product. These instructions contain valuable information to the end user.

**TOOLS  
REQUIRED**



5/16" Nutdriver



12mm & 1/2"  
Combination wrenches



6mm Allen wrench



3/8" Ratchet, Extensions  
1/2" & 12mm Sockets  
7/16" Deep Socket

**READ ALL INSTRUCTIONS BEFORE BEGINNING INSTALLATION**

**STOCK EXHAUST  
SYSTEM REMOVAL**

1. Loosen clamps that hold the muffler body to header outlet.
2. Loosen and remove bolts and nuts holding muffler to mounting bracket. Keep stock hardware for optional re-use.
3. Remove the stock muffler and set it aside. NOTE: It may be necessary to use a penetrating lubricant to loosen the muffler from the head pipe.

**FIGURE 1**



Install bracket#620-P

**FIGURE 2**

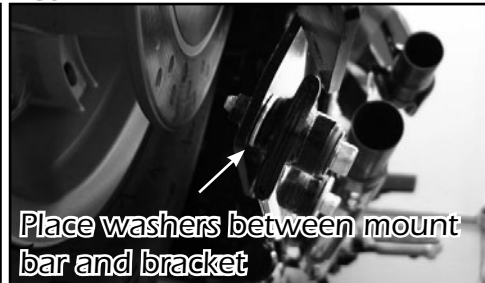

Place washers between mount bar and bracket

**FIGURE 3**



Install hose clamp

**FIGURE 4**

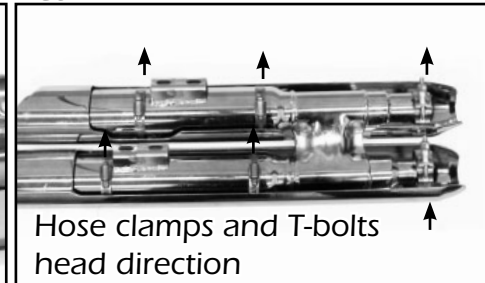

Hose clamps and T-bolts head direction

**VANCE & HINES EXHAUST SYSTEM INSTALLATION**

1. Install mounting bracket 620-P (supplied) to motorcycle mount bar (Figure 1) by using two M8x50mm socket head bolts (supplied), two M8 lock nuts (supplied) and the two stock washers. Note: Place stock washers between mount bar and muffler body mounting bracket (Figure 2). (Re-use of stock bolts and nuts is optional)
2. Remove the muffler assemblies and heat shields from their protective packaging. Place each heat shield on a non-abrasive surface such as a towel, blanket or carpet.
3. Install T-bolt clamps (supplied) over the front (notched end) of the mufflers (figure 4), small clamp on top tube, large clamp on lower tube. NOTE: The tightening bolts should be accessible from the bottom.
4. Carefully lay the muffler assembly into the heat shield and loosely install the hose clamps (supplied) by feeding the tail end of the clamp into the heat shield clips (Figure 3). Note the direction of the clamp screw heads, they must be accessible for adjustment when system is installed (Figure 4).
5. Adjust the heat shield so that the muffler body protrudes beyond the heat shield by .25 inches, and the muffler body and heat shield edges are parallel. Tighten band clamps.
6. Slide mufflers onto the head pipes.
7. Slide nut plates (supplied) into muffler body brackets with the flat side towards the bike.
8. Using 5/6" x 5/8" hex head bolts (supplied), attach the mufflers to the bracket.
9. Tighten all hardware.
10. After installation and before starting motorcycle, completely clean pipes and mufflers with soapy water and a clean, soft cloth. NOTE: Any residue, oil, or fingerprints will stain the finish when the metal heats up.
11. Be sure to tighten all hardware before starting your motorcycle.

**EXHAUST CARE - HELPFUL HINTS TO AVOID DISCOLORATION OF EXHAUST SYSTEM**

1. When installing a new set of chrome pipes, make sure your hands are clean and free of oil. After installation, thoroughly clean pipes with a soft cloth and cleaning solvent that will leave no residue (chrome wax / polish, glass cleaner, alcohol, ammonia, etc...) before starting the motorcycle.
2. Avoid long periods of idling as this can cause discoloration.
3. Intake leaks can cause the engine to run lean and overheat, this could lead to discoloration.
4. Make sure there are no exhaust leaks at the junction of the exhaust pipes and cylinder head. We recommend replacing gaskets if they are worn.

**VANCE & HINES OPTIONAL ACCESSORIES**

**FUELPAK**



**FUEL MANAGEMENT:**  
Take the guess work out of fuel injection with Fuelpak Fuel Management. Contact your local dealer or call (562) 921-0071 to order. Visit [fuelpakfi.com](http://fuelpakfi.com) for more information. Fuelpak is intended for racing or off-highway use only, and is not legal for sale or use in California on pollution-controlled vehicles.

PLEASE NOTE: Every effort is made for Vance & Hines Exhaust Systems to provide improved cornering clearance. However, due to design and space limitations on some motorcycle models, ground and cornering clearance may not be improved and in some cases may be reduced. Be sure to follow proper installation instructions.

**PACKING LIST**

**MORE POWER : LESS NOISE**

**ALL PARTS SHOWN ARE ACTUAL SIZE**

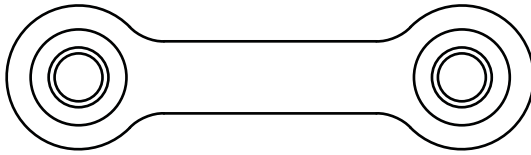

Nut plate x2



M8 metal lock nut x2

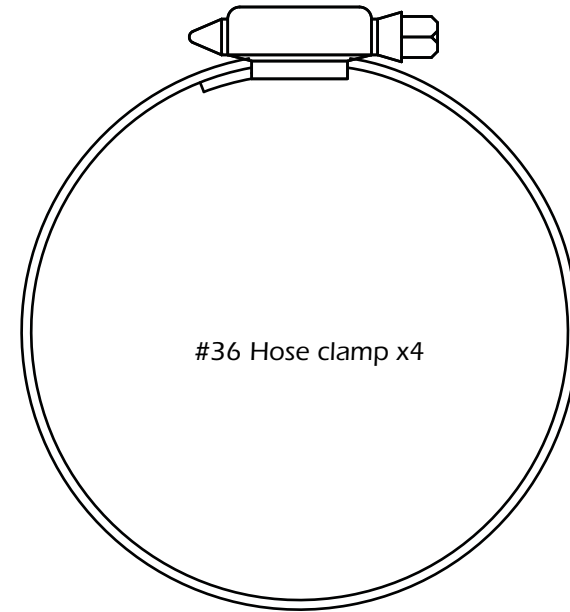

#36 Hose clamp x4

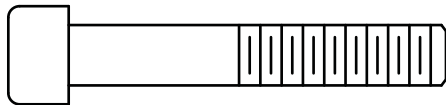

M8x50mm Socked head bolt x2

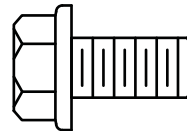

5/16"x5/8" Flange Hd. Bolt x4

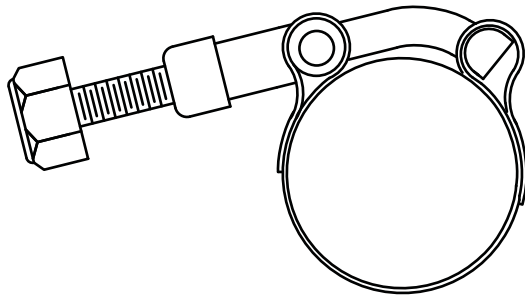

#52 T-bolt clamp x1

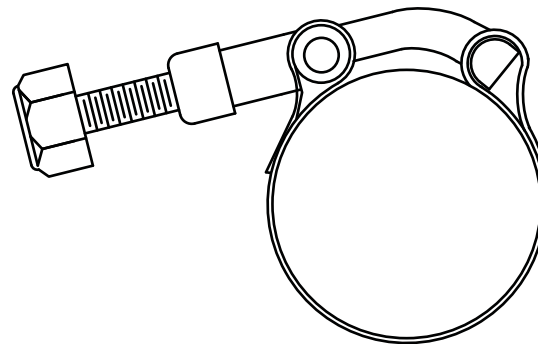

#55 T-bolt clamp x1

**PARTS NOT SHOWN:**

620-P	Bracket	1x
H650RC	Muffler	1x
H655HC	Bottom heat shield	1x
H656HC	Top heat shield	1x
A423R	Baffle	1x

**WARRANTY**

Vance & Hines exhaust systems are warranted against defects in material and workmanship for a period of 90 days from the date of purchase from an authorized dealer. This warranty does not cover discoloration of chrome finishes. This warranty is limited to the repair or replacement of a product proven to be defective from normal use. Vance & Hines exhaust systems are designed to fit and operate on OEM motor and chassis. This warranty does not cover any product subject to abuse, misuse, improper installation or modification.

## FUEL MANAGEMENT

**GET THE MOST OUT OF YOUR RIDING EXPERIENCE...**

AN AFTERMARKET EXHAUST SYSTEM IS ONLY YOUR FIRST STEP, NOW YOU NEED FUEL MANAGEMENT.

### **NOW YOU NEED FUELPAK.**

Your fuel injected Harley-Davidson® is equipped with an ECU (electronic control unit) that's programmed to deliver fuel to the motor based on an air/fuel ratio for a stock air filter and stock exhaust system. When you install a performance exhaust system, your airflow changes, so you need a fuel management system that adjusts your air/fuel ratio to match the changes. That fuel management system is Fuelpak. Fuelpak adds and takes away fuel, allowing for a more precise range of refinement in your air/fuel ratio. Get the perfect fuel management combination with your Vance & Hines exhaust system, get Fuelpak. For more information visit the tuning center at [fuelpakfi.com](http://fuelpakfi.com)

NOTICE: Fuelpak is intended for racing or off-highway use only, and is not legal for sale or use in California on pollution-controlled vehicles.



**MORE POWER : LESS NOISE**

**13861 ROSECRANS AVENUE / SANTA FE SPRINGS, CA 90670**  
**SALES: (562) 921-7461 / TECHNICAL: (562) 926-5291 / FAX: (562) 802-0110**  
**VANCEANDHINES.COM**